

Contenitori universali/Universal storage units

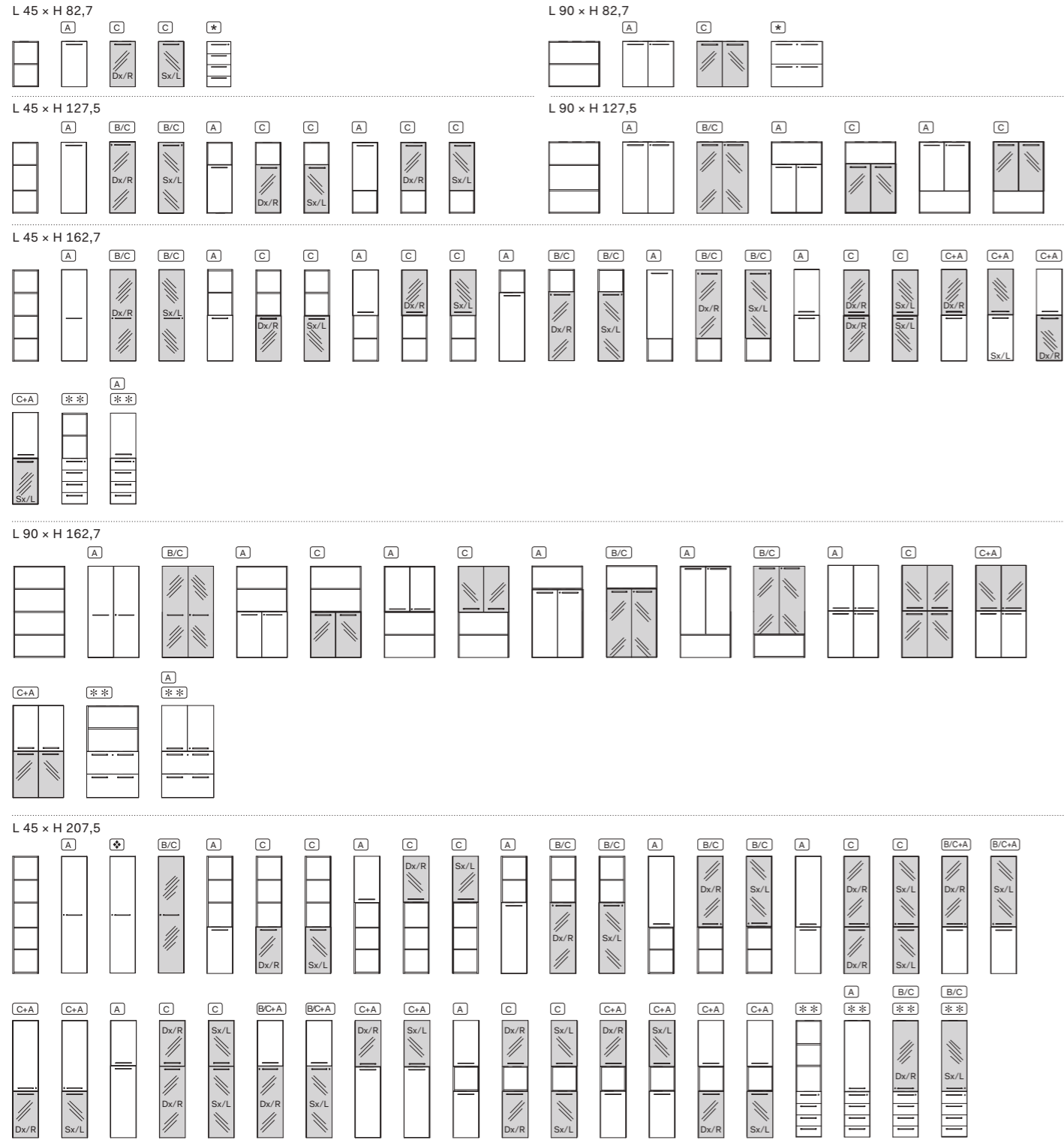

Note:

Tipologie ante vetro disponibili / Available glass doors

A Ante in melaminico / Wooden door;

B Ante vetro acidato con telaio in alluminio dotata di serratura / Acetated glass door with aluminium frame and lock;

C Ante vetro retrolaccato con telaio in alluminio / Rear-lacquered glass door with aluminium frame;

I contenitori P 35 cm sono disponibili solo con ripiani in melaminico/35 cm deep storage units are available only with melamine shelves;

☒ Contenitori appendiabiti disponibili solo P 45 cm / Wardrobe storage units only available in 45 cm depth;

☒ Contenitori disponibili solo P 45 cm / Storage units available only in 45 cm depth;

☒☒ Contenitori sovrapposti disponibili solo P 45 cm / Stackable storage units only available in 45 cm depth;

1 Le dimensioni sono espresse in cm - consultare il listino prezzi per le caratteristiche tecniche, i codici degli articoli e delle finiture / Dimensions are stated in cm - for technical characteristics, article code numbers and finishing see price list.

Contenitori universali/Universal storage units

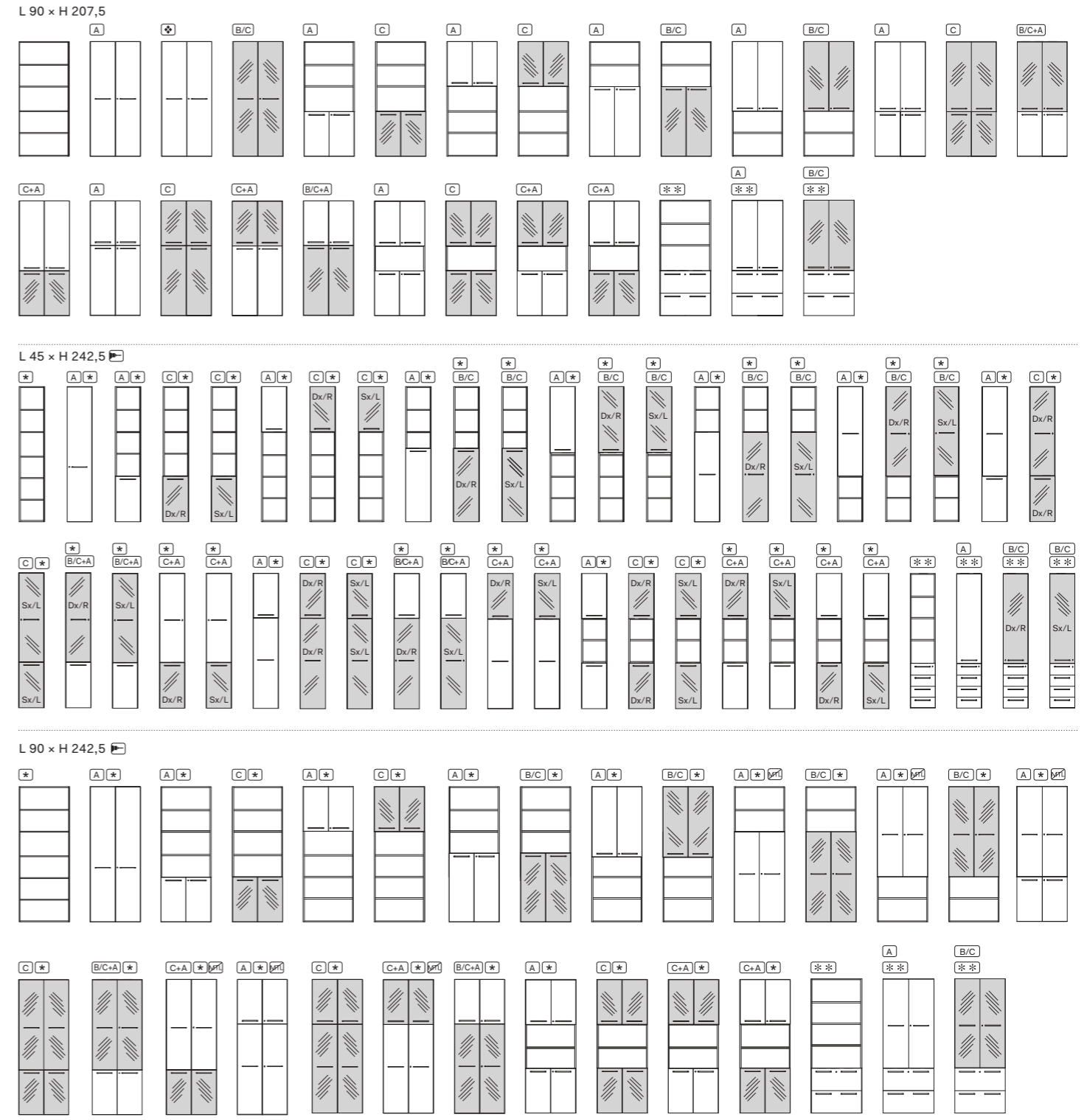

Note: ATTENZIONE: Ripiano in metallo non utilizzabile nelle composizioni contrassegnate con il simbolo ☒ / ATTENTION: Metal shelf not usable in compositions marked with the symbol ☒

Note:

Tipologie ante vetro disponibili / Available glass doors

A Ante in melaminico / Wooden door;

B Ante vetro acidato con telaio in alluminio dotata di serratura / Acetated glass door with aluminium frame and lock;

C Ante vetro retrolaccato con telaio in alluminio / Rear-lacquered glass door with aluminium frame;

I contenitori P 35 cm sono disponibili solo con ripiani in melaminico/35 cm deep storage units are available only with melamine shelves;

☒☒ Contenitori attrezzati disponibili solo P 45 cm / Storage units with accessories only available in 45 cm depth;













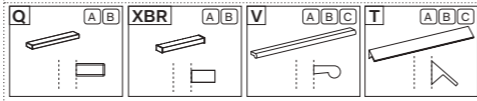













☒☒ Contenitori disponibili solo P 45 cm / Storage units available only in 45 cm depth;

☒☒☒ Contenitori sovrapposti disponibili solo P 45 cm / Stackable storage units only available in 45 cm depth;









1 Le dimensioni sono espresse in cm - consultare il listino prezzi per le caratteristiche tecniche, i codici degli articoli e delle finiture / Dimensions are stated in cm - for technical characteristics, article code numbers and finishing see price list.

☒ I contenitori H 242,5 cm vanno sempre fissati a muro e completati di zoccoli metallici. / The storage units H 242,5 must be fixed to the wall and completed with metal plinth.

Contenitori a giorno/Open storage units

<p>L 45 x H 82,7</p>  <p>503.CU.GA.08.11_P 33,2 503.CU.GB.08.11_P 43 503.CU.GM.08.11_P 43</p>		<p>L 90 x H 82,7</p>  <p>503.CU.GA.08.21_P 33,2 503.CU.GB.08.21_P 43 503.CU.GM.08.21_P 43</p>		<p>Note: 503..._A..._P 33,2 / 503..._B..._P 43: Ripiano in melaminico/Melamine shelf 503..._M..._P 43: Ripiano in metallo/Metal shelf</p> <p>Tipologie maniglie disponibili/Available handle typologies</p>  <p>Maniglia "Q" + "XBR" utilizzabile solo con ante piene o ante in vetro acidate / Handle "Q" + "XBR" to be used only with wooden doors or acetated glass door</p>									
<p>L 45 x H 127,5</p>  <p>503.CU.GA.12.11_P 33,2 503.CU.GB.12.11_P 43 503.CU.GM.12.11_P 43</p>		<p>L 45 x H 127,5</p>  <p>503.CU.SA.12.11_P 33,2 503.CU.SB.12.11_P 43 503.CU.SM.12.11_P 43</p>		<p>L 90 x H 127,5</p>  <p>503.CU.GA.12.21_P 33,2 503.CU.GB.12.21_P 43 503.CU.GM.12.21_P 43</p>		<p>L 90 x H 127,5</p>  <p>503.CU.SA.12.21_P 33,2 503.CU.SB.12.21_P 43 503.CU.SM.12.21_P 43</p>							
<p>L 45 x H 162,7</p>  <p>503.CU.GA.16.11_P 33,2 503.CU.GB.16.11_P 43 503.CU.GM.16.11_P 43</p>		<p>L 45 x H 162,7</p>  <p>503.CU.SA.16.11_P 33,2 503.CU.SB.16.11_P 43 503.CU.SM.16.11_P 43</p> <p>Per ante sovrapposte o parziali /For overlapped or partial doors</p>		<p>L 90 x H 162,7</p>  <p>503.CU.GA.16.21_P 33,2 503.CU.GB.16.21_P 43 503.CU.GM.16.21_P 43</p>		<p>L 90 x H 162,7</p>  <p>503.CU.SA.16.21_P 33,2 503.CU.SB.16.21_P 43 503.CU.SM.16.21_P 43</p> <p>Per ante sovrapposte o parziali /For overlapped or partial doors</p>		<p>L 90 x H 162,7</p>  <p>503.CU.EA.16.21_P 33,2 503.CU.EB.16.21_P 43 503.CU.EM.16.21_P 43</p> <p>Per ante in vetro con telaio in all. anod. /For glass doors with anod. alumim. frame</p>					
<p>L 45 x H 207,5</p>  <p>503.CU.GA.20.11_P 33,2 503.CU.GB.20.11_P 43 503.CU.GM.20.11_P 43</p>		<p>L 45 x H 207,5</p>  <p>503.CU.SA.20.11_P 33,2 503.CU.SB.20.11_P 43 503.CU.SM.20.11_P 43</p> <p>Per ante sovrapposte o parziali /For overlapped or partial doors</p>		<p>L 45 x H 207,5</p>  <p>503.CU.NA.20.11_P 33,2 503.CU.NB.20.11_P 43 503.CU.NM.20.11_P 43</p> <p>Per ante parziali o vano a giorno /For partial doors and open space</p>		<p>L 90 x H 207,5</p>  <p>503.CU.GA.20.21_P 33,2 503.CU.GB.20.21_P 43 503.CU.GM.20.21_P 43</p>		<p>L 90 x H 207,5</p>  <p>503.CU.SA.20.21_P 33,2 503.CU.SB.20.21_P 43 503.CU.SM.20.21_P 43</p> <p>Per ante sovrapposte o parziali /For overlapped or partial doors</p>		<p>L 90 x H 207,5</p>  <p>503.CU.NA.20.21_P 33,2 503.CU.NB.20.21_P 43 503.CU.NM.20.21_P 43</p> <p>Per ante parziali o vano a giorno /For partial doors and open space</p>		<p>L 90 x H 207,5</p>  <p>503.CU.EA.20.21_P 33,2 503.CU.EB.20.21_P 43 503.CU.EM.20.21_P 43</p> <p>Per ante in vetro acidato/For acetated tempered glass doors</p>	
<p>L 45 x H 242,5</p>  <p>503.CU.GB.24.11_P 43 503.CU.GM.24.11_P 43</p> <p>Per ante sovrapposte o parziali /For overlapped or partial doors</p>		<p>L 45 x H 242,5</p>  <p>503.CU.SB.24.11_P 43 503.CU.SM.24.11_P 43</p> <p>Per ante sovrapposte o parziali /For overlapped or partial doors</p>		<p>L 45 x H 242,5</p>  <p>503.CU.NB.24.11_P 43 503.CU.NM.24.11_P 43</p> <p>Per ante parziali o vano a giorno /For partial doors and open space</p>		<p>L 90 x H 242,5</p>  <p>503.CU.GB.24.21_P 43 503.CU.GM.24.21_P 43</p>		<p>L 90 x H 242,5</p>  <p>503.CU.SB.24.21_P 43 503.CU.SM.24.21_P 43</p> <p>Per ante sovrapposte o parziali /For overlapped or partial doors</p>		<p>L 90 x H 242,5</p>  <p>503.CU.NB.24.21_P 43 503.CU.NM.24.21_P 43</p> <p>Per ante parziali o vano a giorno /For partial doors and open space</p>		<p>L 90 x H 242,5</p>  <p>503.CU.EB.24.21_P 43 503.CU.EM.24.21_P 43</p> <p>Per ante parziali H 159,6 in vetro acidato/For partial doors H 159,6 in acetated tempered glass</p>	



























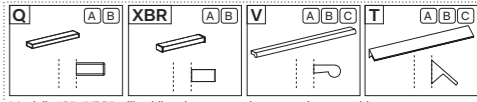









Contenitori attrezzati/Storage units with accessories

<p>L 45 P 45 x H 82,7</p>  <p>503.CU.C0.08_</p>		<p>L 90 P 45 x H 82,7</p>  <p>503.CU.L0.08_</p>		<p>L 90 P 45 x H 82,7</p>  <p>503.CU.F0.08_</p>		<p>L 90 P 45 x H 82,7</p>  <p>503.CU.F0.09_</p>		<p>L 90 P 45 x H 82,7</p>  <p>503.CU.F0.10_</p>		<p>L 89,9 P 42,8 x H 2,8</p>  <p>503.CU.ZF.09_</p> <p>Zoccolo metallico per contenitore basso con frigo bar./Base metal frame for unit with wooden doors and mini-bar</p>		<p>L 45 P 45 x H 207,5</p>  <p>503.CU.P0.20.11_</p>		<p>L 90 P 45 x H 207,5</p>  <p>503.CU.P0.20.21_</p>	
---	--	--	--	--	--	--	--	---	--	--	--	--	--	--	--

Note:

- Le dimensioni sono espresse in cm - consultare il listino prezzi per le caratteristiche tecniche, i codici degli articoli e delle finiture/Dimensions are stated in cm - for technical characteristics, article code numbers and finishing see price list;
- Prodotti non in pronta consegna. Per la disponibilità \ contattare l'ufficio commerciale./Items not in prompt delivery. Please contact the commercial department to check availability;
- I contenitori H 242,5 cm vanno sempre fissati a muro e completati di zoccoli metallici./The storage units H 242,5 must be fixed to the wall and completed with metal plinth;
- I contenitori H 242,5 non possono essere integrati con le ante H 204,4./The storage units H 242,5 cannot be integrated with H 204,4 doors;
- Frigo-bar/Mini-bar.
- Con serratura/With lock;

Ante piene / Wooden doors

<p>L 44,7 P 1,8 x H 79,6</p>  <p>503.CA.10.08_</p>		<p>L 89,6 P 1,8 x H 79,6</p>  <p>503.CA.20.08_</p>		<p>L 89,6 P 1,8 x H 79,6</p>  <p>503.CA.30.08_</p>		<p>L 44,7 P 1,8 x H 124,4</p>  <p>503.CA.10.12_</p>		<p>L 89,6 P 1,8 x H 124,4</p>  <p>503.CA.20.12_</p>		<p>L 89,6 P 1,8 x H 124,4</p>  <p>503.CA.30.12_</p>									
<p>L 44,7 - P 1,8 - H 159,6</p>  <p>503.CA.10.15_</p>		<p>L 89,6 - P 1,8 - H 159,6</p>  <p>503.CA.20.15_</p>		<p>L 44,7 - P 1,8 - H 204,4</p>  <p>503.CA.10.20_</p>		<p>L 89,6 - P 1,8 - H 204,4</p>  <p>503.CA.20.20_</p>		<p>L 44,7 - P 1,8 - H 239,6</p>  <p>503.CA.10.24_</p>		<p>L 89,6 - P 1,8 - H 239,6</p>  <p>503.CA.20.24_</p>									
<p>Composizioni contenitori con ante in melaminico / Composition with storage units with wooden doors</p>																			
<p>L 45 P 35 x H 82,7</p>  <p>503.CC.A0.01_</p>		<p>L 45 P 45 x H 82,7</p>  <p>503.CC.B0.01_</p> <p>503.CC.M0.01_</p>		<p>L 90 P 35 x H 82,7</p>  <p>503.CC.A0.02_</p>		<p>L 90 P 45 x H 82,7</p>  <p>503.CC.B0.02_</p> <p>503.CC.M0.02_</p>		<p>Note: 503..._A..._P 33,2 / 503..._B..._P 43: Ripiano in melaminico/Melamine shelf 503..._M..._P 43: Ripiano in metallo/Metal shelf</p> <p>Tipologie maniglie disponibili/Available handle typologies</p>  <p>Maniglia "Q" + "XBR" utilizzabile solo con ante piene o ante in vetro acidate / Handle "Q" + "XBR" to be used only with wooden doors or acetated glass door</p>											
<p>L 45 P 35 x H 127,5</p>  <p>503.CC.A0.03_</p>		<p>L 45 P 45 x H 127,5</p>  <p>503.CC.B0.03_</p> <p>503.CC.M0.03_</p>		<p>L 90 P 35 x H 127,5</p>  <p>503.CC.A0.04_</p>		<p>L 90 P 45 x H 127,5</p>  <p>503.CC.B0.04_</p> <p>503.CC.M0.04_</p>		<p>L 45 P 35 x H 162,7</p>  <p>503.CC.A0.05_</p>		<p>L 45 P 45 x H 162,7</p>  <p>503.CC.B0.05_</p> <p>503.CC.M0.05_</p>									
<p>L 90 P 35 x H 162,7</p>  <p>503.CC.A0.06_</p>		<p>L 90 P 45 x H 162,7</p>  <p>503.CC.B0.06_</p> <p>503.CC.M0.06_</p>		<p>L 45 P 35 x H 207,5</p>  <p>503.CC.A0.07_</p>		<p>L 45 P 45 x H 207,5</p>  <p>503.CC.B0.07_</p> <p>503.CC.M0.07_</p>		<p>L 90 P 35 x H 207,5</p>  <p>503.CC.A0.08_</p>		<p>L 90 P 45 x H 207,5</p>  <p>503.CC.B0.08_</p> <p>503.CC.M0.08_</p>									
<p>L 45 P 35 x H 207,5</p>  <p>503.CC.A0.09_</p>		<p>L 45 P 45 x H 207,5</p>  <p>503.CC.B0.09_</p> <p>503.CC.M0.09_</p>		<p>L 90 P 35 x H 207,5</p>  <p>503.CC.A0.10_</p>		<p>L 90 P 45 x H 207,5</p>  <p>503.CC.B0.10_</p> <p>503.CC.M0.10_</p>		<p>L 45 P 45 x H 242,5</p>  <p>503.CC.B0.21_</p> <p>503.CC.M0.21_</p>		<p>L 90 P 45 x H 242,5</p>  <p>503.CC.B0.22_</p> <p>503.CC.M0.22_</p>									
<p>L 45 P 45 x H 242,5</p>  <p>503.CC.B0.23_</p> <p>503.CC.M0.23_</p>		<p>L 90 P 45 x H 242,5</p>  <p>503.CC.B0.24_</p>																	

Note:

- Le dimensioni sono espresse in cm - consultare il listino prezzi per le caratteristiche tecniche, i codici degli articoli e delle finiture/Dimensions are stated in cm - for technical characteristics, article code numbers and finishing see price list;
- I contenitori H 242,5 cm vanno sempre fissati a muro e completati di zoccoli metallici./The storage units H 242,5 must be fixed to the wall and completed with metal plinth.
- Con serratura/With lock;

Ante in vetro acidato con telaio in alluminio anodizzato / Acetated glass doors with anodised aluminium frame

L 44,7 P 2 x H 124,4 L 89,6 P 2 x H 124,4 L 44,7 P 2 x H 159,6 L 89,6 P 2 x H 159,6 L 44,7 P 2 x H 204,4 L 89,6 P 2 x H 204,4

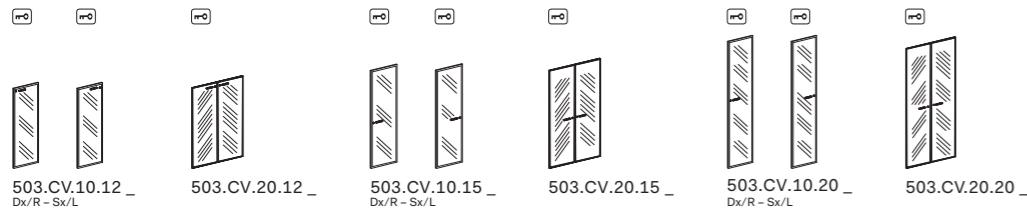

503.CV.10.12_ Dx/R - Sx/L
503.CV.20.12_
503.CV.10.15_ Dx/R - Sx/L
503.CV.20.15_
503.CV.10.20_ Dx/R - Sx/L
503.CV.20.20_

Ante in vetro retrolaccato con telaio in alluminio anodizzato / Rear lacquered glass doors with anodised aluminium frame

L 44,7 P 2 x H 79,6 L 89,6 P 2 x H 79,6 L 44,7 P 2 x H 124,4 L 89,6 P 2 x H 124,4 L 44,7 P 2 x H 159,6 L 89,6 P 2 x H 159,6 L 44,7 P 2 x H 204,4 L 89,6 P 2 x H 204,4

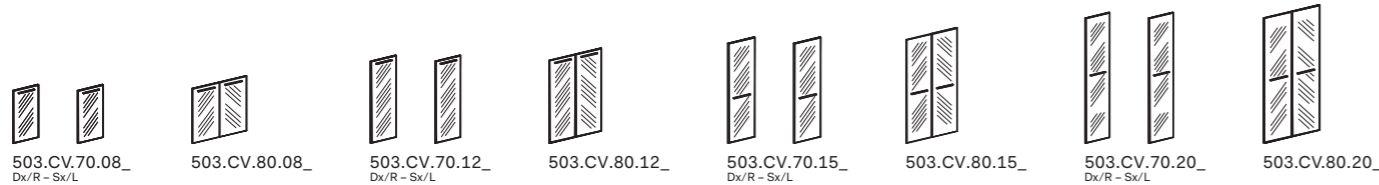

503.CV.70.08_ Dx/R - Sx/L
503.CV.80.08_
503.CV.70.12_ Dx/R - Sx/L
503.CV.80.12_
503.CV.70.15_ Dx/R - Sx/L
503.CV.80.15_
503.CV.70.20_ Dx/R - Sx/L
503.CV.80.20_

Composizioni contenitori con ante in vetro acidato con telaio in alluminio dotate di serratura / Storage units compositions with acetated glass door with aluminium frame and lock

L 45 P 35 x H 127,5 L 45 P 45 x H 127,5 L 90 P 35 x H 127,5 L 90 P 45 x H 127,5

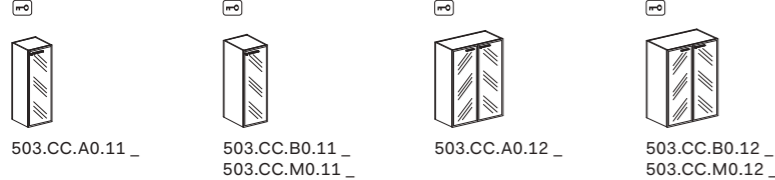

503.CC.A0.11_
503.CC.B0.11_
503.CC.M0.11_
503.CC.A0.12_
503.CC.B0.12_
503.CC.M0.12_

Note:
503...A...P 33,2 / 503...B...P 43: Ripiano in melaminico/Melamine shelf
503...M...P 43: Ripiano in metallo/Metal shelf

Tipologie maniglie disponibili/ Available handle typologies

Maniglia "Q" e "XBR" utilizzabile solo con ante piene o ante in vetro acidate
/ Handle "Q" e "XBR" to be used only with wooden doors or acetated glass door

L 45 P 35 x H 162,7 L 45 P 45 x H 162,7 L 90 P 35 x H 162,7 L 90 P 45 x H 162,7 L 45 P 35 x H 207,5 L 45 P 45 x H 207,5 L 90 P 35 x H 207,5

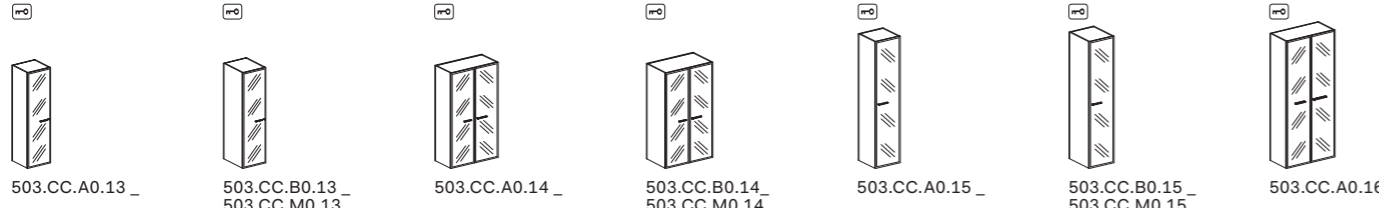

503.CC.A0.13_
503.CC.B0.13_
503.CC.M0.13_
503.CC.A0.14_
503.CC.B0.14_
503.CC.M0.14_
503.CC.A0.15_
503.CC.B0.15_
503.CC.M0.15_
503.CC.A0.16_

L 90 P 45 x H 207,5 L 45 P 35 x H 207,5 L 45 P 45 x H 207,5 L 90 P 35 x H 207,5 L 90 P 45 x H 207,5 L 45 P 45 x H 242,5 L 90 P 45 x H 242,5

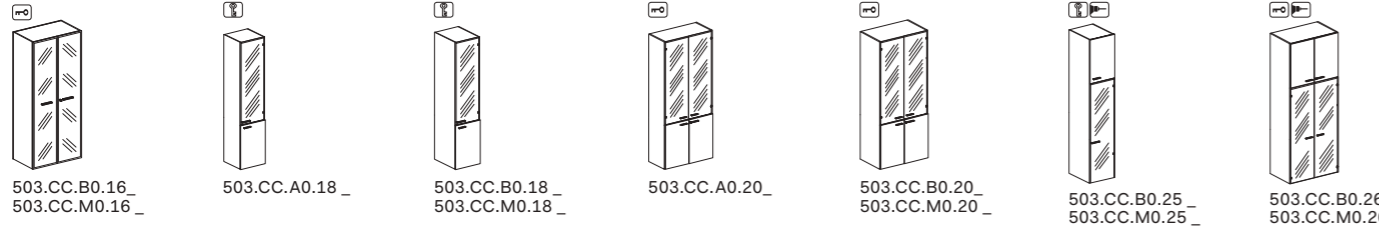

503.CC.B0.16_
503.CC.M0.16_
503.CC.A0.18_
503.CC.B0.18_
503.CC.M0.18_
503.CC.A0.20_
503.CC.B0.20_
503.CC.M0.20_
503.CC.B0.25_
503.CC.M0.25_
503.CC.B0.26_
503.CC.M0.26_

Contenitori H 74/Storage units H 74

L 80 P 33 x 71,5 L 80 P 33 x 71,5



550.CG.01.08_ A giorno/Open
550.CC.02.08_ Con ante/With doors
550.CG.13.08_ H 1,8
550.CG.14.08_ H 2,5
550.CG.15.08_ H 3,8
550.CG.11.08_ H 2,5
550.CG.12.08_ H 1,8
Zoccolo/Base frame (Optional)

Note: Aggiungere sempre il Top sp. 1,8 o 2,5 (altezza totale è di 74 cm); 3,8 cm (altezza totale è di 75,5 cm) / Always add the 1,8 or 2,5 cm thick tops (height is 74 cm); 3,8 cm (height is 75,5 cm)

Note:
 Le dimensioni sono espresse in cm - consultare il listino prezzi per le caratteristiche tecniche, i codici degli articoli e delle finiture/Dimensions are stated in cm - for technical characteristics, article code numbers and finishing see price list;
 I contenitori H 242,5 cm vanno sempre fissati a muro e completati di zoccoli metallici.
/The storage units H 242,5 must be fixed to the wall and completed with metal plinth.
 Con serratura/With lock;
 Con serratura (solo ante superiore-inferiore in vetro)/With lock (only upper-lower glass door);

Componenti e accessori per contenitori/Components and accessories for storage units

H 2,8



550.CU.ZA.04_ L 44,9 P 33
550.CU.ZB.04_ L 44,9 P 42,8
550.CU.ZA.09_ L 89,9 P 33
550.CU.ZB.09_ L 89,9 P 42,8
Zoccoli metallici/Metal base frames
550.CS.P1.00_ L 33
550.CS.P2.00_ L 39
550.CS.P3.00_ L 33
550.CS.A3.08_ L 90
550.CS.A4.08_ L 90
550.CS.A5.08_ L 90

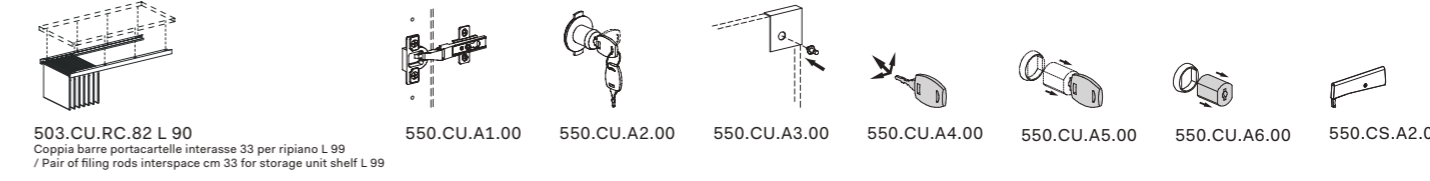

503.CU.RC.82 L 90
Coppia barre portacartelle interasse 33 per ripiano L 99
/ Pair of filing rods interspace 33 for storage unit shelf L 99
550.CU.A1.00
550.CU.A2.00
550.CU.A3.00
550.CU.A4.00
550.CU.A5.00
550.CU.A6.00
550.CS.A2.00

Componenti e accessori per contenitori/Components and accessories for storage units

P 35/45 x H 1,8

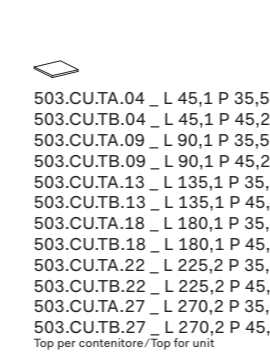

503.CU.TA.04_ L 45,1 P 35,5
503.CU.TB.04_ L 45,1 P 45,2
503.CU.TA.09_ L 90,1 P 35,5
503.CU.TB.09_ L 90,1 P 45,2
503.CU.TA.13_ L 135,1 P 35,5
503.CU.TB.13_ L 135,1 P 45,2
503.CU.TA.18_ L 180,1 P 35,5
503.CU.TB.18_ L 180,1 P 45,2
503.CU.TA.22_ L 225,2 P 35,5
503.CU.TB.22_ L 225,2 P 45,2
503.CU.TA.27_ L 270,2 P 35,5
503.CU.TB.27_ L 270,2 P 45,2
Top per contenitore/Top for unit

P 47,2 x H 1,8

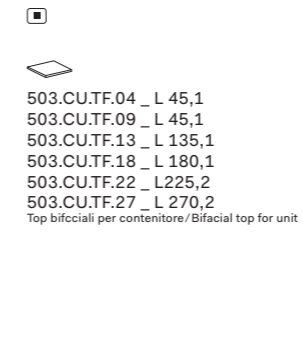

503.CU.TF.04_ L 45,1
503.CU.TF.09_ L 45,1
503.CU.TF.13_ L 135,1
503.CU.TB.09_ L 90,1 P 45,2
503.CU.TA.13_ L 135,1 P 35,5
503.CU.TB.13_ L 135,1 P 45,2
503.CU.TA.18_ L 180,1 P 35,5
503.CU.TB.18_ L 180,1 P 45,2
503.CU.TA.22_ L 225,2 P 35,5
503.CU.TB.22_ L 225,2 P 45,2
503.CU.TA.27_ L 270,2 P 35,5
503.CU.TB.27_ L 270,2 P 45,2
Top bifacciale per contenitore/Bifacial top for unit

L 1,8

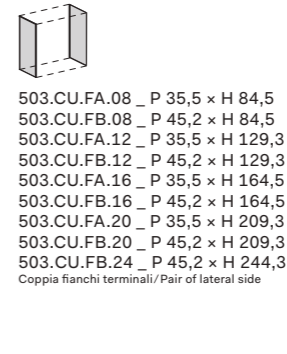

503.CU.FA.08_ P 35,5 x H 84,5
503.CU.FB.08_ P 45,2 x H 84,5
503.CU.FA.12_ P 35,5 x H 129,3
503.CU.FB.12_ P 45,2 x H 129,3
503.CU.FA.16_ P 35,5 x H 164,5
503.CU.FB.16_ P 45,2 x H 164,5
503.CU.FA.20_ P 35,5 x H 209,3
503.CU.FB.20_ P 45,2 x H 209,3
503.CU.FB.24_ P 45,2 x H 244,3
Coppia fianchi terminali/Pair of lateral side

P 1,8

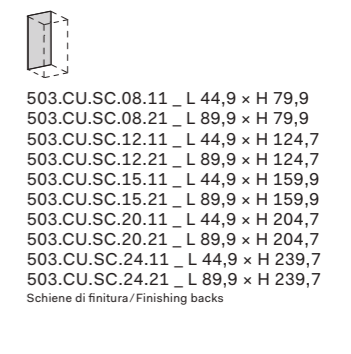

503.CU.SC.08.11_ L 44,9 x H 79,9
503.CU.SC.08.21_ L 89,9 x H 79,9
503.CU.SC.12.11_ L 44,9 x H 124,7
503.CU.SC.12.21_ L 89,9 x H 124,7
503.CU.SC.15.11_ L 44,9 x H 159,9
503.CU.SC.15.21_ L 89,9 x H 159,9
503.CU.SC.20.11_ L 44,9 x H 204,7
503.CU.SC.20.21_ L 89,9 x H 204,7
503.CU.SC.24.11_ L 44,9 x H 239,7
503.CU.SC.24.21_ L 89,9 x H 239,7
Schiene di finitura/Finishing backs

L 41,4 x H 2,5

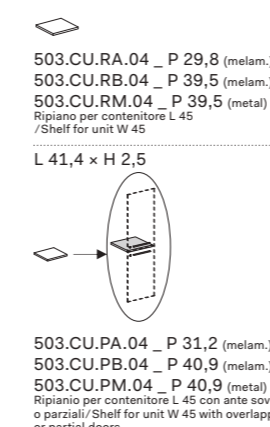

503.CU.RA.04_ P 29,8 (melam.)
503.CU.RB.04_ P 39,5 (melam.)
503.CU.RM.04_ P 39,5 (metal)
Ripiano per contenitore L 45
/ Shelf for unit W 45

L 41,4 x H 2,5

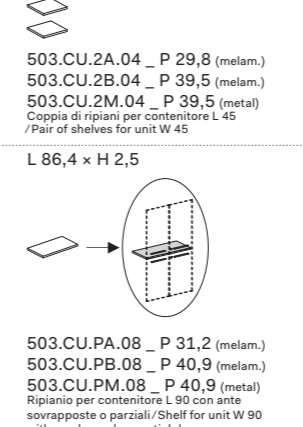

503.CU.2A.04_ P 29,8 (melam.)
503.CU.2B.04_ P 39,5 (melam.)
503.CU.2M.04_ P 39,5 (metal)
Coppia di ripiani per contenitore L 45
/ Pair of shelves for unit W 45

L 86 x H 2,5

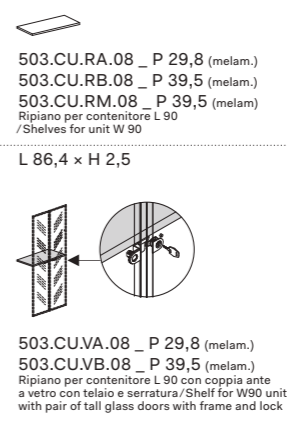

503.CU.RA.08_ P 29,8 (melam.)
503.CU.RB.08_ P 39,5 (melam.)
503.CU.RM.08_ P 39,5 (metal)
Ripiano per contenitore L 90
/ Shelves for unit W 90

L 86 x H 2,5

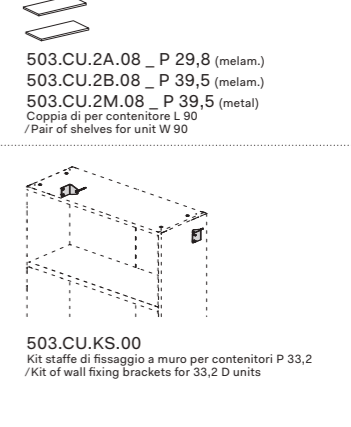

503.CU.2A.08_ P 29,8 (melam.)
503.CU.2B.08_ P 39,5 (melam.)
503.CU.2M.08_ P 39,5 (metal)
Coppia di per contenitore L 90
/ Pair of shelves for unit W 90
503.CU.KS.00
Kit staffe di fissaggio a muro per contenitori P 33,2
/ Kit of wall fixing brackets for 33.2 D units

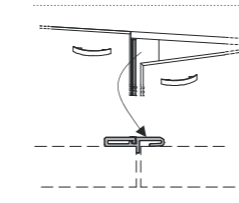

503.CU.PP.01.11 H 79,6
503.CU.PP.01.31 H 124,4
503.CU.PP.01.41 H 159,6
503.CU.PP.01.51 H 204,4
Profilo battiporta parapolvere per contenitori
/ Dust-proof / door-latch profile for units

L 90 P 43 x H 25

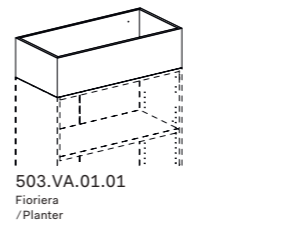

503.VA.01.01
/ Planter

L 90 P 1,8 x H 25

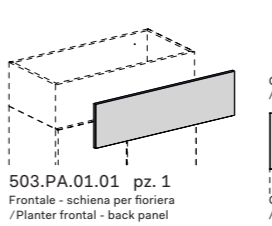

503.PA.01.01 pz. 1
Frontale - schiena per fioriera
/ Planter frontal - back panel

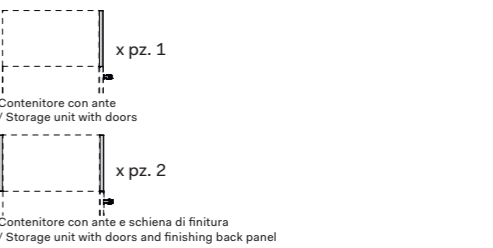

x pz. 1
Contenitore con ante
/ Storage unit with doors
x pz. 2
Contenitore con ante e schiena di finitura
/ Storage unit with doors and finishing back panel

Note:
 Le dimensioni sono espresse in cm - consultare il listino prezzi per le caratteristiche tecniche, i codici degli articoli e delle finiture/Dimensions are stated in cm - for technical characteristics, article code numbers and finishing see price list;
 Prodotti non in pronta consegna. Per la disponibilità contattare l'ufficio commerciale/Items not in prompt delivery. Please contact the commercial department to check availability;
 Con serratura/With lock;
 Fino ad esaurimento/Until exhaustion.
 I contenitori sono componibili, sovrapponibili e vanno completati con i top/storage units are modular, stackable and they must be completed with tops;